



**MultiPrep™ 8"**  
PRECISION POLISHING SYSTEMS

*PRECISE SEMIAUTOMATIC  
SAMPLE PREPARATION FOR A  
WIDE RANGE OF MATERIALS*

Quality Products for Metallographic Sample Preparation & Analysis

The **MultiPrep™ System** is a programmable machine that enables precise semiautomatic sample preparation of a wide range of materials for microscopic (**optical, SEM, FIB, TEM, AFM, etc.**) evaluation.

Capabilities include parallel polishing, angle polishing, site-specific polishing or any combination thereof. It provides reproducible results by eliminating inconsistencies between users, regardless of their skill.

Dual micrometers (pitch and roll) allow precise sample tilt adjustments relative to the abrasive plane. A rigid Z-indexing spindle maintains the predefined geometric orientation throughout the grinding/polishing process. Digital indicators enable quantifiable material removal, which can be monitored real-time (front), or preset (rear) for unattended operation. Variable speed rotation and oscillation maximize use of the entire grinding/polishing disc and minimize artifacts. Adjustable load control expands its capability to handle a range of small (delicate) to large samples.

**Precision/magnetic platens, accessories and consumables are sold separately.**

Item	Description
15-2200	MultiPrep™ System, 8", 100-240 V
15-2200-TEM	MultiPrep™ TEM System, 8", 100-240 V
Dims: 15" W x 27" D x 22" H (381 x 685 x 560 mm)	
Weight: 95 lb. (43 kg)	

### Grinder/Polisher Features:

- Variable platen speed: 5-350 RPM (5 RPM increments)
- 7" color LCD touchscreen with keypad entry to control all functions
- Intuitive interface optimized for productivity and function
- Seamless integration with optional #5-7100 AD-5™ Fluid Dispenser for fully automatic operation
- 0.5 HP (375 W) high-torque motor
- Stable RIM, aluminum and stainless steel construction
- Timer for count-up or countdown operation
- Clockwise/counterclockwise platen rotation
- Electronic coolant control with adjustable valve
- Retractable coolant nozzle to allow quick and easy sample/bowl cleaning
- Molded one-piece corrosion and impact resistant enclosure with overflow diversion to protect internal components
- Emergency shut-off switch
- **CE** compliant for EU
- Two (2) year warranty
- Designed and manufactured by Allied in the USA 

## Positioning Head



### Positioning Head Features:

- Front digital indicator to display real-time material removal (sample advancement) with zeroing function, 1 µm resolution
- Precision spindle that indexes the sample perpendicular to the platen and can rotate simultaneously
- Dual axis, micrometer controlled angular positioning of the sample (pitch and roll): +10° / -2.5° range (0.02° increments)
- Rear digital indicator to display vertical positioning (static) with zeroing function, 1 µm resolution
- Automatic sample oscillation, adjustable sweep with 8 speeds
- Full or limited automatic sample rotation with 8 speeds
- Cam-locking system that eliminates the need for tools and allows for precise repositioning of fixtures
- Variable sample load: 0-600 g (100 g increments)

## Rotation Drive Systems

The MultiPrep™ system is available with either a gear drive or an O-ring drive for sample rotation.

### Gear Drive

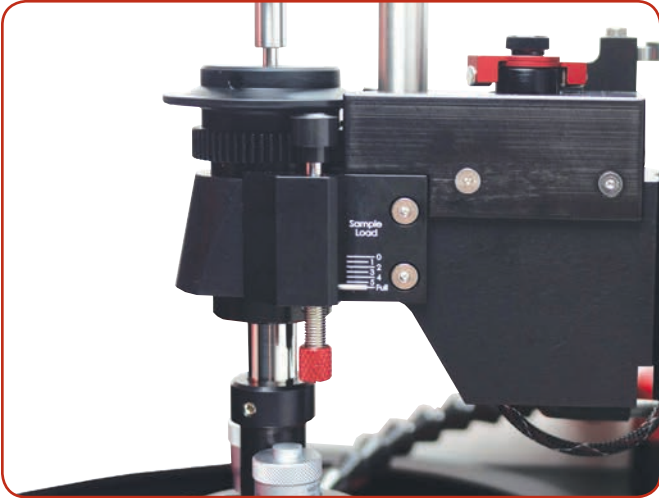

The gear-drive system is recommended for preparing larger, hard, tough or encapsulated materials. It delivers non-slip rotation for higher load-bearing applications.

**This drive is included in the #15-2200 system.**

### O-Ring Drive

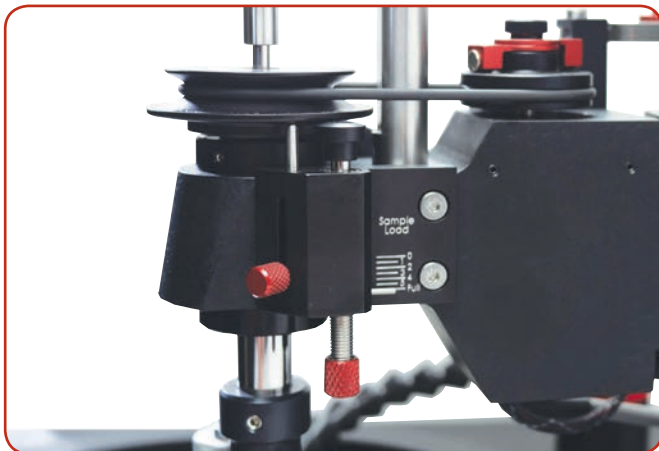

The O-ring drive is better suited for preparing delicate unencapsulated materials typically associated with TEM wedge thinning. The O-ring is able to absorb subtle resistive movements that could otherwise cause material fractures.

**This drive is included in the #15-2200-TEM system.**

## LCD Touchscreen

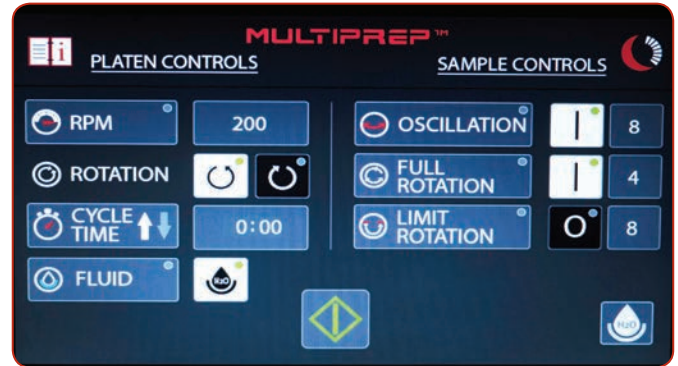

The 7" color LCD touchscreen is used to control all functions and is extremely easy to navigate, allowing greater efficiency among users. The intuitive interface includes icons and is optimized for productivity and function.

## Precision Platens

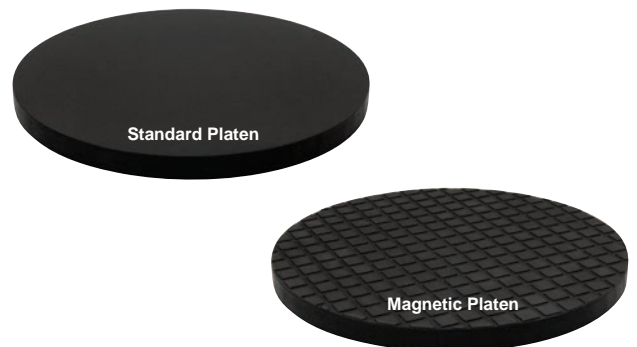

Precision platens are lapped parallel within 2 microns and hard anodized for maximum wear resistance. They are used with plain or adhesive backed discs. Magnetic platens combine a precision platen with a cross-hatched magnetic surface for maximum flatness and adherence. This allows all magnetic system cloths/abrasive discs or ferromagnetic discs to be utilized.

Item	Description
10-1005	Precision Platen, 8" (203 mm)
10-1005M	Precision Magnetic Platen, 8" (203 mm)

## Accessories

A wide variety of standard fixtures and accessories are available. The cam-locking interface offers tool-free attachment and removal for ease of use. Custom fixtures are available for various applications. Contact Allied for more information.

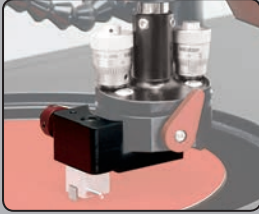

**15-1005**  
Cam-Lock Adapter  
for cross-sectioning/  
thinning paddles

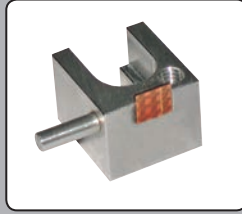

**15-1010**  
Cross-Sectioning  
Paddle

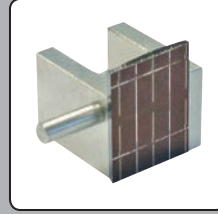

**15-1010-RE**  
Cross-Sectioning  
Paddle with  
Reference Edge



**15-1013**  
TEM Wedge/FIB  
Thinning Paddle



**15-1014**  
TEM Wedge/FIB  
Thinning Fixture



**15-1018**  
SIMS/TEM  
Thinning Fixture

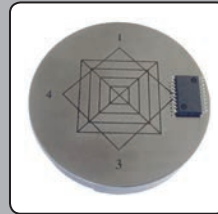

**15-1020**  
Parallel Polishing  
Fixture, 2.25" (57 mm)

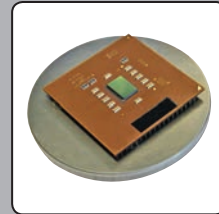

**15-1020-80 or  
15-1020-100**  
Parallel Polishing  
Fixture, 80 or 100 mm



**15-1025**  
Teardrop Fixture,  
40 mm Mount Capacity



**15-1035**  
Weight Kit

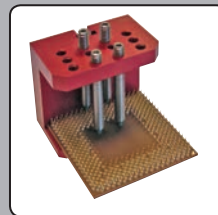

**15-1045**  
Multipurpose Fixture,  
2" Wide

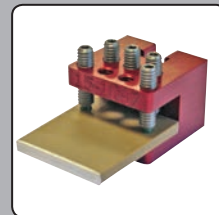

**15-1047**  
Multipurpose Fixture,  
1" Wide

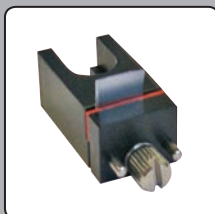

**15-1050**  
Cross-Sectioning Paddle,  
Clamp Style



**15-ACMPF**  
MultiPrep™ Assorted  
Accessory/Fixture Set

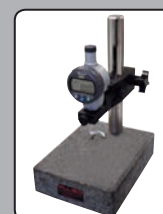

**120-30015**  
Digital Indicator  
Measurement System

## Common Applications

### Circuit Delayering

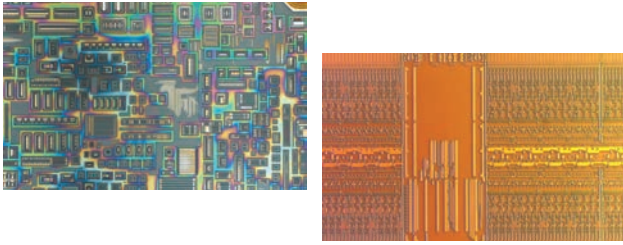

Remove circuit layers for defect review and physical FA.

### Precision Cross-Sectioning



Prepare precise encapsulated or unencapsulated cross-sections of die or package level semiconductor devices, as well as a wide variety of other materials.

### SIMS Thinning



Thin semiconductor or other substrates to less than 200 nm to enable backside SIMS analysis.

### Serial Sectioning

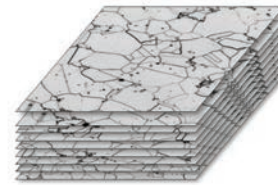

Prepare polished regions of 2D structures at specific intervals to allow 3D reconstruction of materials for analysis.

### TEM Wedge Thinning

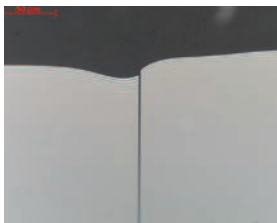

Prepare wedge specimens of bulk materials for TEM analysis.

### Optics/Optical Device Polishing

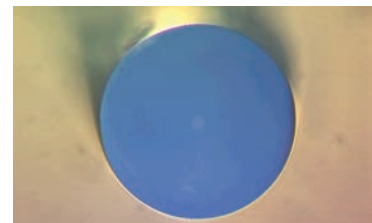

Polish a wide variety of optical components and bare fiber.

### Thin Sectioning

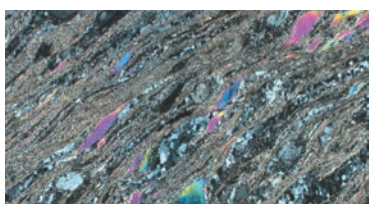

Prepare thin sections for petrography/geology.

### EBSD Preparation



Prepare artifact-free surfaces on a wide variety of materials for EBSD analysis.

## AD-5™ Fluid Dispenser

The AD-5™ fluid dispenser provides automatic, unattended application of abrasive polishing suspensions and lubricants. Its functions are programmed using the touchpad switches on its face plate, and activated through the MultiPrep™, and can also be used with **ANY** brand polishing machine as a standalone system.

Timed, volume-controlled, variable frequency dispensing delivers reproducible results by eliminating inconsistencies between operators. This increases productivity and efficiency, while reducing consumables usage. Intuitive menu navigation and simple logic programming make the dispenser easy to use.

The AD-5™ features five (5) dispensing positions, two of which include a flush cycle to prevent clogging when using colloidal suspensions. Peristaltic pump technology offers mist-free drip delivery to the polishing surface.

### Features:

- Five (5) dispensing positions, 16 oz. (500 mL) capacity (128 oz. [3.8 L] adapter kit available)
- User-defined menu labeling (abrasive type & size, lubricant, cloth, material and menu name)
- Pump reverse after cycle to prevent dripping/contamination
- Remote function enabling seamless integration and automatic activation with Allied's grinding and polishing systems
- Local function to allow standalone operation with any grinder/polisher
- Pulse duration: 0.5-6 seconds (0.5 second increments)
- Pulse frequency: 1-10 per minute
- In-cycle priming that allows temporary "full rate" dispensing onto polishing surface
- One-touch priming function for quick, initial charging of new cloths
- One-touch activation independent of menu for simple operation
- Pre-start charging of new/dry polishing cloths
- Allows dispensing of colloidal suspensions (silica, silica/alumina and alumina) with rinse/flush function to avoid clogging
- Two (2) positions with high-speed pumps for oxide polishing
- 25 programmable menus
- Touchpad switches to control all functions
- Backlit 4-line LCD
- CE compliant for EU
- Two (2) year warranty
- Designed and manufactured by Allied in the USA 



MultiPrep™ System with AD-5™ Fluid Dispenser

Item	Description
5-7100	AD-5™, 100-240 V
	Dims: 8" W x 25" D x 9" H (203 x 635 x 228 mm)
	Weight: 28 lb. (13 kg)



25 programmable menus

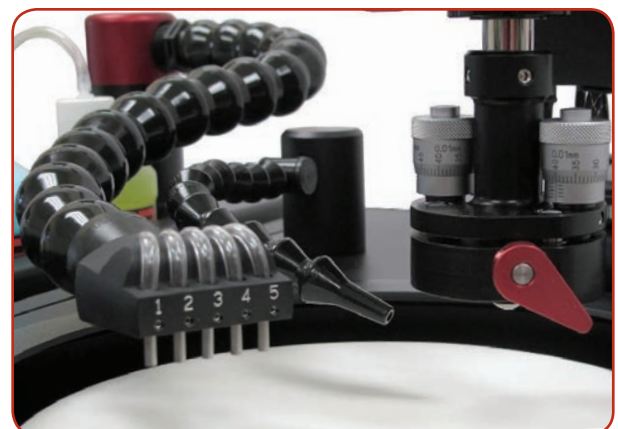

Convenient pivoting arm with nozzle design featuring stainless tips that are easily removed for cleaning

## Dimensions

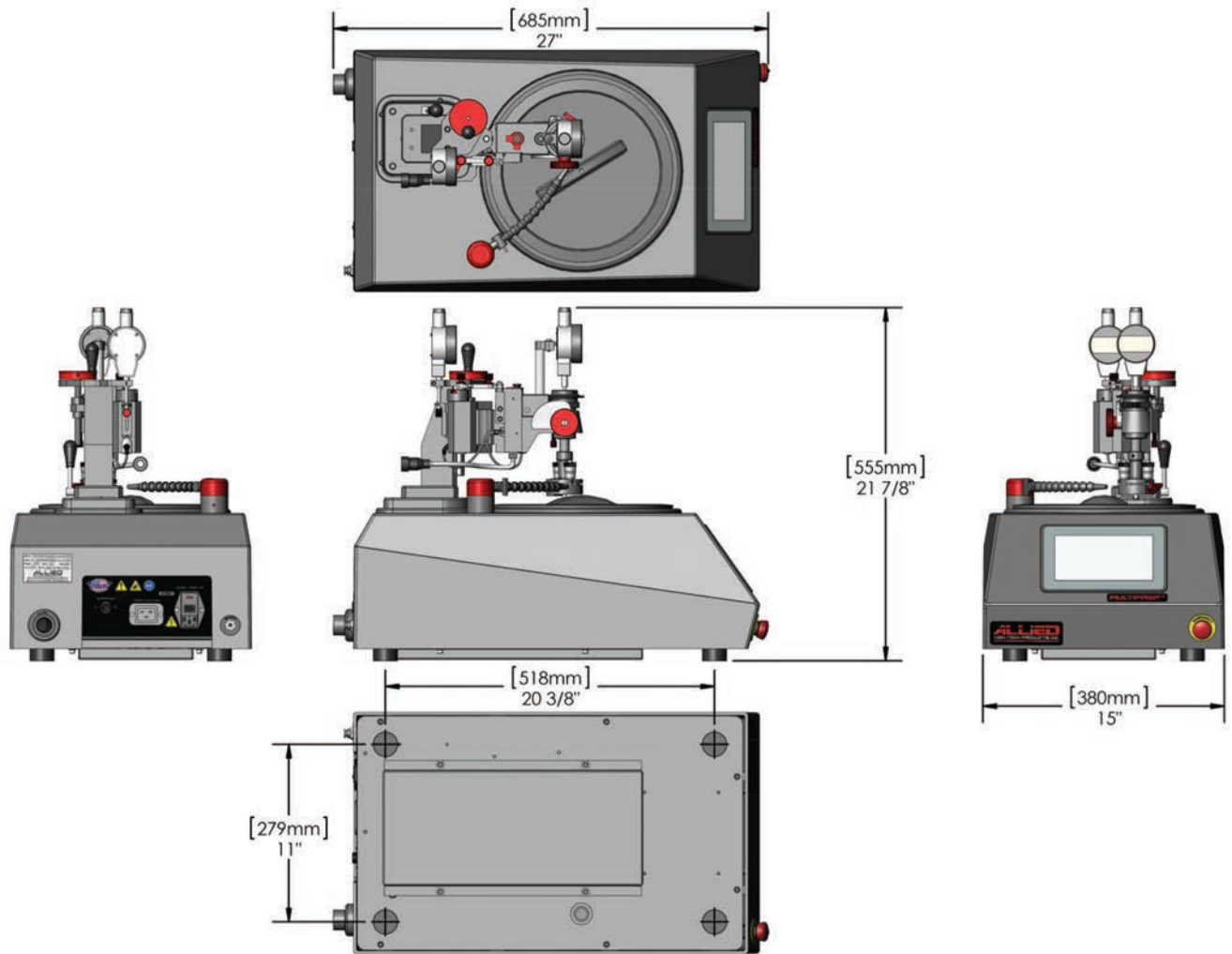

### Grinder/Polisher Specifications

<b>Platen RPM</b>	5-350
<b>Power (HP)</b>	0.5
<b>Power (W)</b>	375
<b>Display</b>	7" Color LCD Touchscreen
<b>Electronics</b>	Microprocessor controlled
<b>Operating Voltages</b>	100-240 V
<b>CE</b>	EMC Directive 2014/30/EU LVD Directive: 2014/35/EU MD Directive: 2006/42/EC
<b>Weight</b>	95 lb. (43 kg)
<b>Warranty</b>	2 years
<b>Included Items</b>	Splash Ring and Platen Cover, Fixture/Accessory Storage Case, MultiPrep™ Procedures CD, Operation Manual, Calibration Kit: Precision 8" (230 mm) Platen, Dial Indicator + Micrometer Alignment Fixture

### Positioning Head Specifications

<b>Sample RPM</b>	8 speeds
<b>Sample Oscillation</b>	8 speeds
<b>Sample Advancements</b>	1 μm resolution
<b>Angular Positioning</b>	+10°/-2.5° range (0.02° increments)
<b>Sample Load (g)</b>	0-600

# Global Distribution of the World's Finest Products



Brochure #: MPS-2018

Equipment is subject to change due to innovations/improvements at any time.



Designed and Manufactured by  
Allied High Tech Products, Inc.  
in the USA

**ALLIED**  
HIGH TECH PRODUCTS, INC.

2376 E. Pacifica Place, Rancho Dominguez, CA 90220  
310.635.2466 Worldwide / 800.675.1118 U.S. & Canada  
Visit us online! [AlliedHighTech.com](http://AlliedHighTech.com)